

**How to Create Sounds Right Away**  
(Even If You Have Never Touched  
a Synthesizer Before!)

**Como Crear Sonidos de Inmediato**  
(¡Aunque Nunca Antes Haya Tocado  
un Sintetizador!)

● Digital Synthesizer/Sintetizador Digital ●

**CASIO CZ Series / Serie**

# Sound Synthesis Handbook Manual de Síntesis Sonora

< Appendix > The Essentials —  
"Synthesizer Sound Seminar"

< Suplemento > Lo Esencial —  
"Seminario sobre el Sonido del Sintetizador"

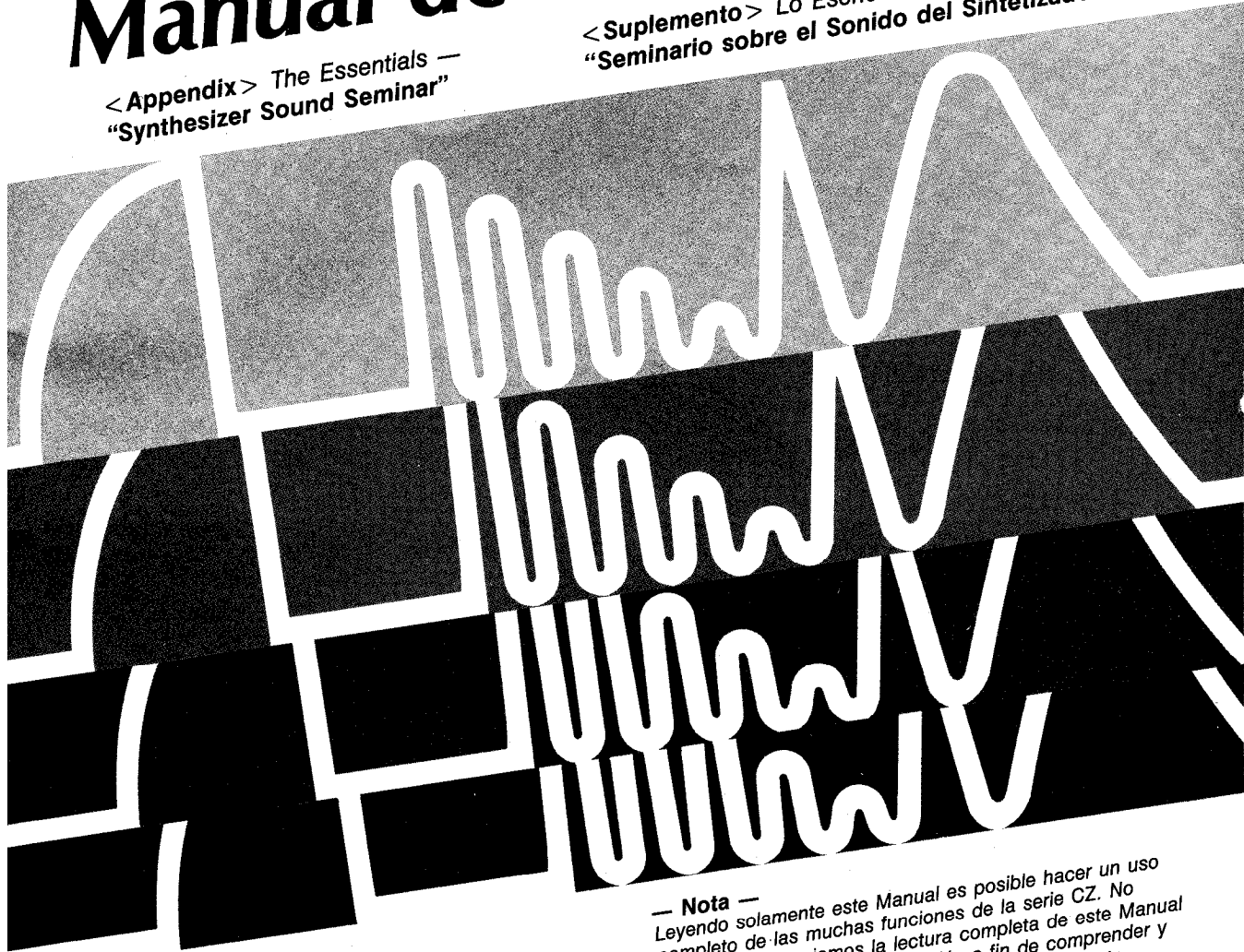

— Note —

It is possible to make full use of the CZ-series' many functions by reading this Handbook only. However, we strongly recommend that you read through this Handbook together with the Operation Manual in order to be able to thoroughly understand and enjoy this advanced instrument and use it correctly for longer service life.

— Nota —

Leyendo solamente este Manual es posible hacer un uso completo de las muchas funciones de la serie CZ. No obstante, aconsejamos la lectura completa de este Manual junto con el Manual de Operación a fin de comprender y disfrutar completamente este avanzado instrumento, usándolo correctamente para prolongar su vida útil.

**CASIO**  
英西

## Introduction

This booklet explains the operation of the Casio CZ-series from a different viewpoint than the Operation Manual.

It was written with people in mind who want to play their new instrument right away, who are less interested in theory and more in practical tips for creating new sounds.

For those who have no experience with synthesizers at all and are using one for the first time, the appendix "Synthesizer Sound Seminar" is recommended reading.

## Contents

---

<b>Part 1</b>	First, Let's Create Some Sounds! .....	1
<b>Part 2</b>	CZ-Series Sound Synthesis .....	9
<b>Part 3</b>	Tips for Sound Synthesis — Effective Techniques .....	15
<b>Appendix</b>	The Essentials — "The Synthesizer Sound Seminar"...	21

---

# *PART 1*

---

## First, Let's Create Some Sounds!

---

This part is intended for those of you who don't want to take the trouble to read the Operation Manual right away, who are less interested in theory and more in actual sound synthesis. The explanations given in the following will allow you to experience the synthesis of sounds for yourself.

## First, listen to the 32 sample sounds

The CZ-series offers 16 preset tones and 16 internal tones for a total of 32 factory-programmed sample sounds.

Listen to each of these sounds by performing the following simple operations.

The CZ-series synthesizers have no built-in speakers. In order to listen to the sound, connect your instrument to external speaker systems such as a keyboard amplifier or use headphones.

### (1) Press the power switch to turn the instrument on.

➔ As soon as power is applied to the synthesizer, the PRESET and 1 indicators in the PROGRAMMER section will light up.

This indicates that the preset tone no. 1 "BRASS ENS 1" (brass ensemble 1) has been selected, as displayed on the LCD.

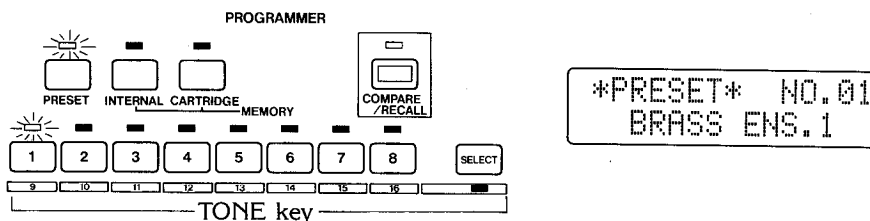

### (2) Now listen to each of the 16 preset tones.

#### \* How to select a preset tone

When the PRESET indicator is lit, you can select the preset tone of your choice by using the 8 tone selector keys. Pressing the SELECT key causes its indicator to light up, showing that you can now select preset tones no. 9 to 16. The name of the tone as well as its number are displayed on the LCD.

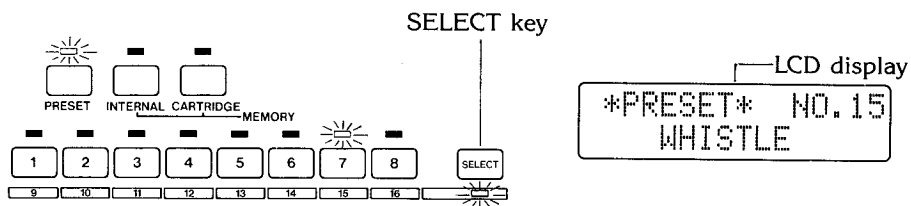

### (3) Let's listen to the 16 internal tones.

#### \* How to select internal tones

Press the INTERNAL key. Its indicator will light up. As with the preset tones, you can now select the internal tone of your choice by using the tone selector and SELECT keys. The LCD will now display the tone number only.

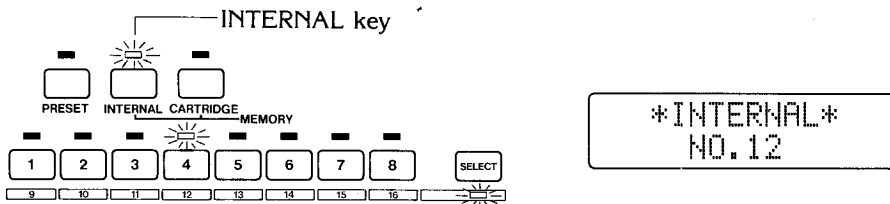

## Internal Memory and Internal Tones

This synthesizer has an internal memory which lets you store up to 16 tones you have created yourself. Factory-programmed tones are stored in the internal memory at shipment of this synthesizer. These are the internal tones shown on the right. In other words, you can memorize your own tones by replacing the internal tones with them and then recall them in exactly the same manner as just explained for the internal tones.

\* If you press the P button on the bottom of this synthesizer, the 16 internal tones will be restored.

No.	Tone name	Polyphonic	No.	Tone name	Polyphonic
1	FANTASTIC PIANO	4	9	FUNKY CLAVI.	4
2	BRASS ENSEMBLE 3	4	10	SOFT ORGAN	4
3	SYNTH. CLOCKENSPIEL	4	11	CARILLON	4
4	STRING ENSEMBLE 2	4	12	SOUTHERN WING	4
5	BLUES HARMONICA	4	13	SYNTH. STRING 2	4
6	XYLOPHONE	4	14	SYNTH. BLOCKS	8
7	FANTASTIC SOUND 1	4	15	FANTASTIC SOUND 2	4
8	FAT BASS	4	16	STEEL DRUM 1	8

## Altering the sample sounds

There are two basic methods for creating your own sounds with the CZ-series. You can either select a sample sound that is already close to the kind of tone you would like and alter it until it suits your taste, or else combine the various tone elements to synthesize a new sound right from the beginning. Here we will explain the first method of altering a sample sound. This will make it easier for you to understand how sound synthesis with the CZ-series actually works.

\* See the Operation Manual, p. 20.

No detailed explanations will be given concerning the meanings of the various numeric values etc. that appear in the operation examples below.

Instead, we are sure that actual experience of sound synthesis will help you to gradually understand the implications of the various operations, so please simply alter the sounds as indicated.

For more detailed explanations, please refer to the Operation Manual, p. 28 ff.

**Example:** Changing the preset tone no. 1 "Brass Ens 1" into an exotic "Oriental Brass" sound and storing it in internal memory no. 15.

### (1) Select the preset tone no. 1 "Brass Ens 1":

➔ See "How to select a preset tone" on p. 2.

### (2) Raise the pitch range by one octave.

① Press the OCTAVE key.

➔ The display shown on the right will appear on the LCD. [This indicates that the octave setting for BRASS ENS 1 is currently "RANGE = 0".]

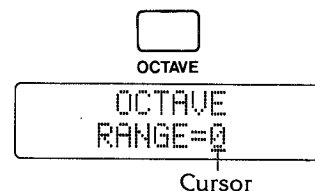

\* The cursor is the mark that indicates the position where a value can be changed.

## NOTE

Whenever you press any key such as VIBRATO, WAVE FORM, ENV, etc., the respective value set for the selected tone will be displayed in the same manner as shown for the octave range setting above. Pressing these buttons again returns the respective setting to the original value.

② Press the  key once.

➔ The value above the cursor changes to “+1” and the pitch range is thus shifted up by one octave.

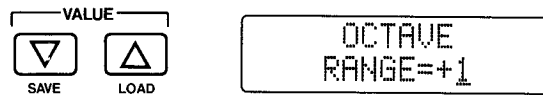

## The COMPARE/RECALL Key

When you perform the operation described above in (2)-②, the indicator above the COMPARE/RECALL key will light up, indicating that a sample sound has been altered. (In our example, the pitch range of the tone “Brass Ens 1” has been raised by one octave.) If you now press the COMPARE/RECALL key, the indicator will go out and you will be able to hear the original sample sound before the alteration, i.e. in our case the Brass Ens 1 tone. Press the key to compare the sounds before and after alteration. By using this button and simply pressing a key on the keyboard, you can listen to the sound you are altering as well as the original sound any time.



**Note:** After you have compared the original sound with the altered one, be sure to continue the alteration procedure after having returned to the altered sound, in which case the COMPARE/RECALL indicator will be lit.

**(3) Now, let's change the pitch envelope to achieve a wavering effect during the attack time.**

① Press the DCO 1 ENV key.

➔ The LCD will show the display on the right.

[The parameter values for Step 1 of the pitch envelope are “RATE = 99” and “LEVEL = 33”. The cursor is positioned under the RATE value.]



② Press the  key to display Step 2 of the envelope.

➔ The LCD will show the display on the right.



**NOTE**

By performing the operations explained in the steps above, you now know that the parameter values for the preset tone "Brass Env 1" are RATE = 99, LEVEL = 33 for Step 1 and RATE = 68, LEVEL = 0 for Step 2, producing the envelope shown on the right. The "rate" parameters indicate the "attack angle" while the "level" parameters show the "height" of the envelope for the respective steps. The maximum value for each of these parameters is 99 while the minimum value is 0.  
 → See page 30 ~ 32 of the Operation Manual for details.

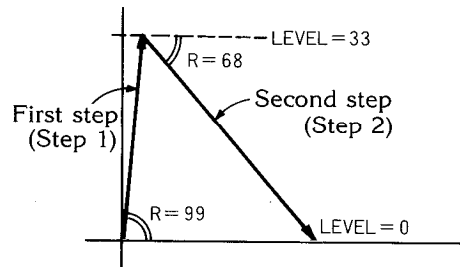

- ③ Press the  $\square$  SAVE key to set the value to 50.
- \* Each time the  $\square$  SAVE key is pressed, the value will decrease by 1. Keeping this key depressed will cause the value to decrease continuously. If the value has decreased beyond the desired point, simply press the  $\square$  LOAD key to increase it again.



**NOTE**

The operation explained in ③ changes the rate (slope) of Step 2 from 68 to 50, producing the pitch envelope illustrated on the right.  
 \* The wavering effect, which is determined by the angle of the slope, will now be stronger due to the gentler slope of the envelope (indicated by the shaded section).

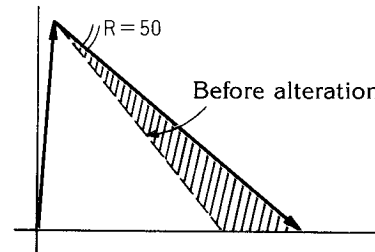

- \* Press the COMPARE/RECALL key in order to compare the altered sound with the previous one. After comparison, return to the altered sound by pressing this key again. (The indicator will light up.)

**(4) By altering the volume envelope, a reverberation (reverb) effect can be obtained.**

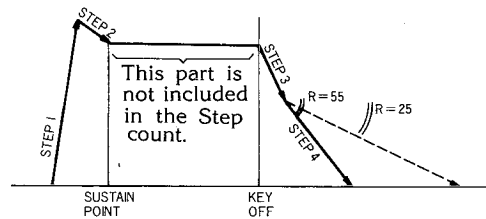

**NOTE**

The volume envelope of the tone Brass Ens 1 is illustrated on the right. A reverb effect can be obtained by changing the rate value of Step 4 from 55 to 22.



- ① Press the DCA 1 ENV key.
- ➔ The LCD will show the display on the right.



- ② Press the  key three times to proceed to Step 4.  
 ➔ Make sure that the LCD displays Step 4.  
 \* If you have gone too far, press the  key to return to Step 4.

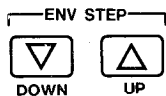



```
AMP STEP4 END
RATE=55 LEVEL=00
```

- ③ Change the rate value from 55 to 22.



```
AMP STEP4 END
RATE=22 LEVEL=00
```

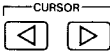

### How to Change the Values on the LCD

The values indicated on the LCD (Liquid Crystal Display) are changed using the following keys.

\*  The cursor (---) indicates the value which can currently be changed with the VALUE keys. When more than 2 variable values are displayed, these keys are used to move the cursor to the position of the value you want to change. As a rule, the  key moves the cursor from left to right and from upper to lower line, while the  performs the opposite movement.

**Note:** When only 2 variable values are displayed, the cursor will move in the same manner whichever key is pressed.

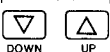
\*  The value indicated by the cursor will decrease by one every time the  key is pressed and increase by one every time the  key is pressed. Keeping these keys depressed increases or decreases the value continuously.

\*  When an ENV key (of a DCO, DCW, etc.) has been pressed in order to change the values of envelope parameters, these keys are used to proceed to the step you wish to alter. Pressing the  key advances the step number by 1, pressing the  key decreases the step number by 1.

### (5) Next, we will change the DETUNE value to add a perfect fifth harmony.

- ① Press the detune key.  
 ➔ The LCD will show the display on the right.



```
DETUNE(+) OCT=0
NOTE=00 FINE=07
```

- ② Press the  key to move the cursor to the position below the NOTE value.

```
DETUNE(+) OCT=0
NOTE=00 FINE=07
```

- ③ Press the  key to change the NOTE value from 00 to 07.

```
DETUNE(+) OCT=0
NOTE=07 FINE=07
```

**NOTE:** A perfect fifth is the note seven semitones above the root (basic note).

- \* You have thus completed the alteration of the tone.  
 Play something on the keyboard to listen to this new tone, a brass sound with an oriental feeling to it.



**(6) Now that you have created a new sound, store it in an internal memory (no. 15 in the following example).**

- ① Set the PROTECT switch on the back of the synthesizer to OFF.
- ② Keep the WRITE key depressed until the operation of step ④ is completed.
  - ➔ The LCD will show the display on the right.
  - In addition, all indicators in the Programmer section except the COMPARE/RECALL indicator will go out.



- ③ Press the INTERNAL key. The INTERNAL indicator will light up.

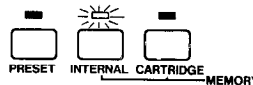

- ④ Press the SELECT key and press the tone selector key  $\frac{15}{15}$ . The LCD will show the display on the right, indicating that the tone has been stored in the memory. (You can now release the WRITE key.)

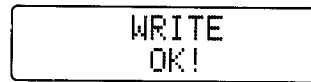
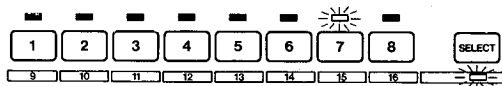

- \* You have thus stored the "Oriental Brass" sound, an alteration of preset tone no. 1 "Brass Ens 1", in the internal memory no. 15. From now on, you can recall this new sound any time just as you would an internal tone. When you want to restore the original internal tone no. 15, press the P button on the bottom of the unit.

# *PART 2*

---

## CZ-Series Sound Synthesis

---

This part of the Handbook will tell you more about the basic ideas behind sound synthesis with the CZ-series.

If you read it while remembering the operations explained in Part 1, you will find it even easier to understand sound synthesis.

## Block Structure of the CZ-Series (as Compared to an Analog Synthesizer)

The fascinating thing about the CZ-series instruments is not only their realistic, clear sound, but also the simplicity of sound creation they offer. The CZ-series does away with one of the major drawbacks of previous digital synthesizers, namely that it was extremely difficult to actually synthesize the kind of sound one had in mind. Instead, you can now easily create any sound you want as you please. The secret behind this ability is that the CZ-series has inherited the basic easy-to-understand structure of sound synthesis from the analog synthesizer. In other words, the CZ-series combines the superior sound of a digital synthesizer with the easy-to-understand principles of sound synthesis offered by analog instruments. In the following, we will explain the block structure of the CZ-series while comparing it to that of an analog synthesizer.

**Note:** To those of you who have never used synthesizers before, we strongly recommend reading the appendix "Synthesizer Sound Seminar" first.

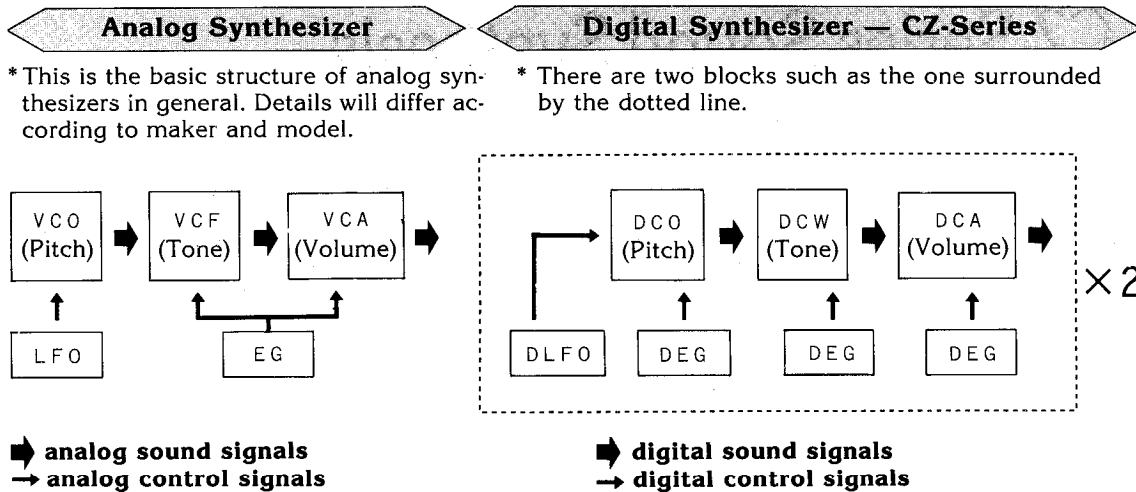

Looking at the above diagram, you will recognize that the CZ-series has practically the same block structure as analog synthesizers.

- **DCO (Digital Controlled Oscillator)**

- corresponds to the VCO (Voltage Controlled Oscillator) of an analog synthesizer. This digital circuit determines the pitch and the basic wave form\* of a sound.

- \* The CZ-series offers about 10 times as many basic wave forms as a normal analog synthesizer.

- **DCW (Digital Controlled Wave)**

- corresponds to the VCF (Voltage Controlled Filter) of an analog synthesizer. This digital circuit controls the tone color of a sound.

- **DCA (Digital Controlled Amplifier)**

- corresponds to the VCA (Voltage Controlled Amplifier) of an analog synthesizer. This digital circuit controls the volume of a sound.

- **DEG (Digital Envelope Generator)**

- corresponds to the EG (Envelope Generator) of an analog synthesizer. Controls the change of pitch, tone color and volume over time according to a maximum of 16 parameters.

- **DLFO (Digital Low Frequency Oscillator)**

- corresponds to the LFO (Low Frequency Oscillator) of an analog synthesizer. This circuit generates low frequency waves for vibrato effects.

- \* The OCTAVE function is included in the DCOs.

This shows that it is easy to comprehend the various blocks of the CZ-series along the lines of analog synthesizers, meaning that you can create totally new sounds without having to learn any new kind of synthesis.

Please note that the CZ-series offers two line systems consisting of the blocks shown above, so that the complete block structure is as shown below.

## Detune and Line Select

The CZ-series has two lines with the block structure shown above, namely Line 1 and Line 2, which are connected as shown below.

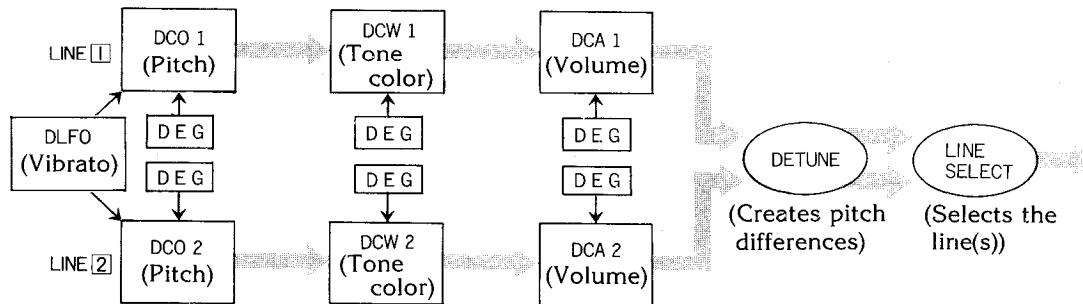

After sounds have been created on Line 1 and/or 2, a pitch difference can be obtained with the Detune function while the line outputs can be designated with Line Select.

- **Detune** ..... Determines the Line 1/Line 2 pitch difference. (Note 1)  
The pitch difference can be designated in units of one octave, one semitone or 1/60 semitone. It is also possible to determine whether the pitch is raised (+) or lowered (-).
- **Line Select** ... This determines which lines are output or which lines are combined. (Note 2)
  - 1 : Outputs Line 1 only.
  - 2 : Outputs Line 2 only.
  - 1 + 2 : Line 1 is output together with the detuned Line 2.
  - 1 + 1 : Line 1 is output together with the detuned Line 1.
  - \* 1 and 2 indicate the detuned lines.

**Note 1:** When 1 + 1 is designated with Line Select, Line 1 is output together with the detuned Line 1 (Line 1 with an altered pitch). In other words, setting a Detune value will detune Line 2 when 1 + 2 is designated and Line 1 if 1 + 1 is designated.

**Note 2:** When 1 or 2 have been designated with Line Select, the synthesizer is 8-voice polyphonic. When 1 + 1 or 1 + 2 have been designated, it is 4-voice polyphonic.

The Detune and Line Select functions let you create a variety of effects by combining the different sounds synthesized on each line or combining detuned and normal-pitch tones for a fatter, spacier sound or to obtain various nuances. For example, by combining a normal-pitch strings tone with a slightly detuned strings tone, you can achieve an even more realistic sound. Another interesting example is the combination of an organ tone with key click noise for a funky jazz organ sound. As you can see, the Detune and Line Select functions play important part in CZ-series sound synthesis.

# Connection Between the Various Keys and Their Operation

We are sure that the explanations given above have enabled you to understand the principles of sound synthesis with the CZ-series. We would now like to show you how the various keys actually interrelate. Please refer to the following diagram.

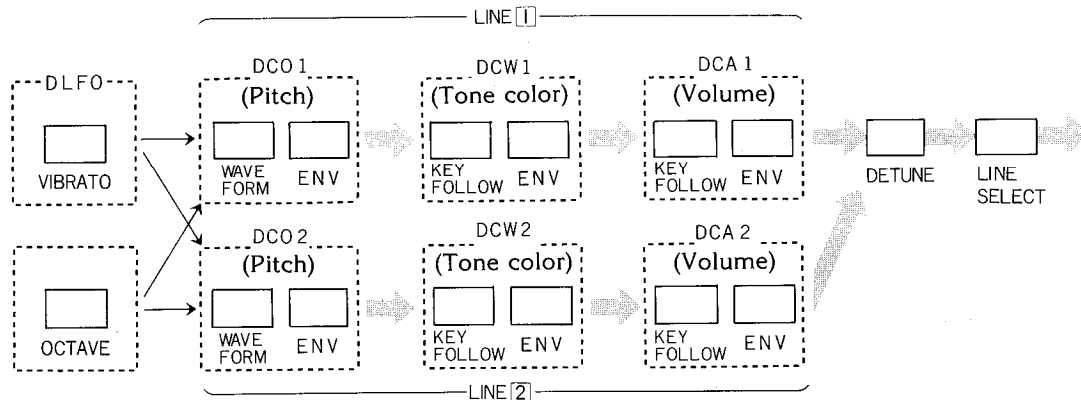

Please compare this diagram with the one on page 11. As you can see, the 6 DEGs available for the various blocks are indicated by the ENV (envelope) keys for DCO 1, DCW 1, etc. Also, you can see that there is an OCTAVE parameter for each DCO. All in all, the key layout more or less corresponds to the block structure shown in the diagram on page 11.

There are 16 keys in all. With the exception of the LINE SELECT key on the extreme right, all other 15 keys cause the values set for the respective blocks to be displayed on the LCD when pressed. These 15 keys are called parameter keys.

CZ-series sound synthesis is accomplished by displaying the values for the blocks you want to alter on the LCD by pressing the respective key and then altering the displayed values with the CURSOR keys  $\leftarrow$  and  $\rightarrow$ , the VALUE keys  $\nabla$  and  $\triangle$ , etc.

## Basic Procedure for Sound Synthesis

\* This explains the procedure for altering the sample sounds.

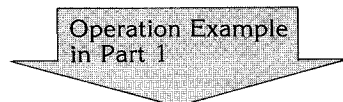

**1**  
Select the tone you want to use as the basis for your sound from among the sample sounds (preset and internal tones).

(1) ..... 3P

**2**  
Press the respective parameter key to display the values for the block you wish to change on the LCD.

(2)— **3** ..... 4P

(3)— **4** ..... 4,5P

(4)— **5** ..... 5P

(5)— **6** ..... 6P

**3**  
 (Use the CURSOR keys and VALUE keys etc. to change the displayed values.)

- (2) — ② ..... 3P
- (3) — ② ③ ..... 4P
- (4) — ② ③ ..... 5P
- (5) — ② ③ ..... 6P

When you want to alter more than one block, repeat operations ② and ③.

**4**  
 Designate the line(s) you want to output with LINE SELECT.

\* This operation is not explained in Part 1 since the output line is not changed in the example.

**5**  
 Store the synthesized sound in the internal memory or a cartridge memory.

- (6) — ① ② ③ ④ ..... 6,7P

\* The settings for RING and NOISE are performed in ② ~ ④.

The lower part of the diagram refers to the operation procedures explained in Part 1 "First, Let's Create Some Sounds!". Please look up the respective operations in Part 1 (p. 3 ~ p. 7). We hope that these explanations have made the basic ideas behind the operations used for sound synthesis clear to you. Please refer to the Operation Manual for the meanings of the settings for each block.

# *PART 3*

---

## Tips for Sound Synthesis — Effective Techniques

---

In order to be able to make full use of the many functions built into the CZ-series synthesizers, we would like to provide you with some practical sound synthesis know-how.





## Tips for Sound Synthesis – Effective Techniques

The following will give you some practical tips on sound synthesis that should enable you to make full use of the CZ-series potential.

### (1) Choosing the Wave Form

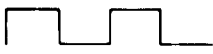
The wave form is one of the major factors which determine a sound. The first step to successful sound synthesis is therefore to understand the characteristics of the various wave forms. In order to help you, we have listed up the major characteristics of each wave form preset on the CZ-series synthesizers.

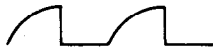
(To better understand these characteristics, select the preset tone no. 1 “Brass Ens 1” and switch to the wave forms indicated below.)

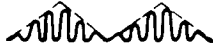
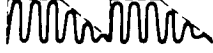
Wave form	Merit
1. Saw-tooth 	A bright tone color particularly suited to strings and brass sounds.
2. Square 	A simple tone color suitable for woodwinds such as clarinet and oboe.
3. Pulse 	A sharp tone color for funky sounds.
4. Double sine 	A shrill, bright tone color.
5. Saw pulse 	A brassy, metallic sound.
6. Resonance I 	A funky tone color with characteristics depending on the WAVE ENVELOPE setting
7. Resonance II 	A funky tone color with characteristics depending on the WAVE ENVELOPE setting
8. Resonance III 	A funky tone color with characteristics depending on the WAVE ENVELOPE setting

When any of the wave forms 1 to 5 is selected and the wave envelope level set to 0, a sine wave is output. This technique is used to output sine waves when necessary.



## (2) Using the DCO Envelope Generator (Pitch Envelope)

### ① Percussive attack using the pitch envelope

Setting a fast attack and decay time for the pitch envelope creates a sound with a percussive attack. Please note, however, that this percussive attack will not be audible if the attack of the DCA envelope is too slow.

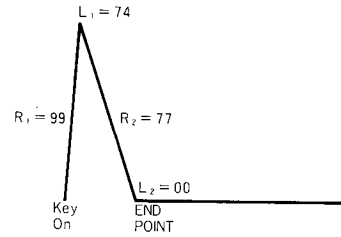

### ② Auto glide effect using the pitch envelope

First, the pitch envelope is set so that it rises very quickly to a point just below one octave in Step 1. Then set the Step 1 rate of the DCA envelope to about 60 so that the first step of the pitch envelope cannot be heard.

Set the sustain point in Step 2 of the pitch envelope so that the envelope slowly approaches the one octave (L = 66) pitch.

With this setting, you have programmed an auto glide effect, causing the pitch to slowly rise when a key is pressed.

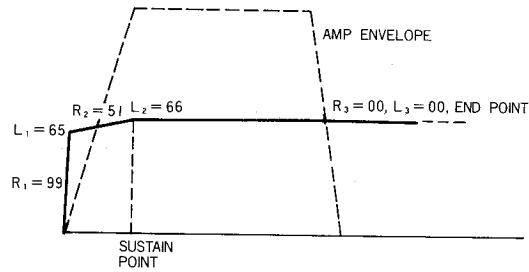

### ③ Using the pitch envelope to produce a guitar sound with distortion and picking effects

By letting the pitch vibrate rapidly over a distance of one octave, a characteristic attack of a distortion guitar sound can be synthesized.

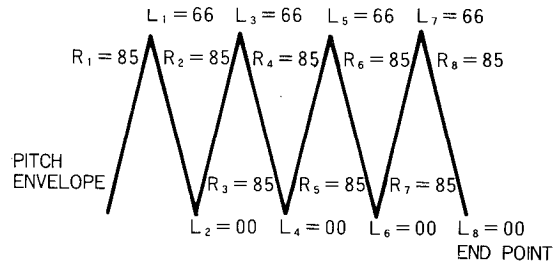

## (3) Using the DCW Envelope Generator (Wave Envelope)

### Using the wave envelope to create a wah-wah sound

Select any of the resonance wave forms (I — III).

By setting the wave envelope as shown below, a wah-wah effect can be achieved.

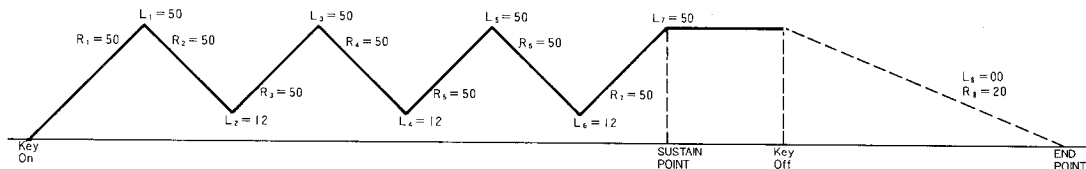

#### (4) Using the DCA Envelope Generator (Amp Envelope)

##### ① An echo effect using the DCA envelope generator

A double echo effect will be heard when a key is released.

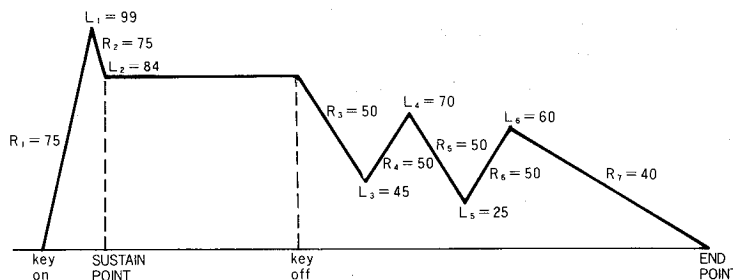

##### ② Using the DCA envelope generator to produce a piano-like envelope with a sudden decay

If a key is released before the Sustain Point is reached, the envelope jumps to the step where the End Point has been designated. This can be utilized by setting the Sustain Point in a step where the decay is already completed (level = 00) and entering a relatively fast rate for the following step, where the End Point is set.

With this kind of envelope, the sound will expand as long as the key is pressed and decay suddenly when it is released.

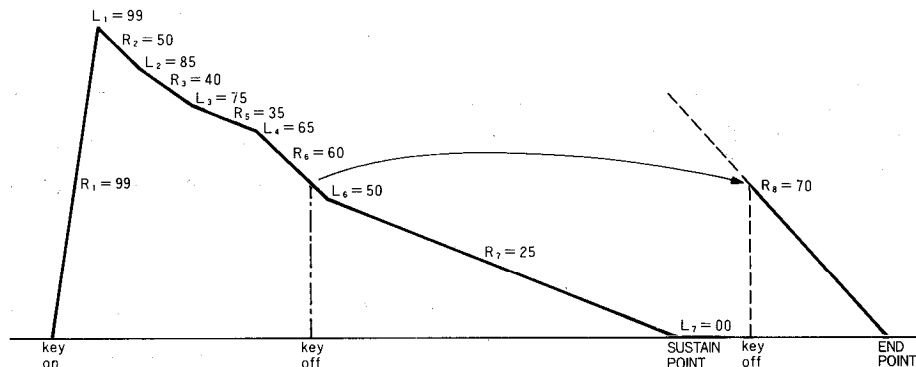

##### ③ You can also use the DCA envelope generator to achieve the kind of attack typical of brass wind instruments with a tonguing effect.

If you set the attack of the envelope as shown below, you can produce the kind of tonguing effect typical of brass wind instruments.

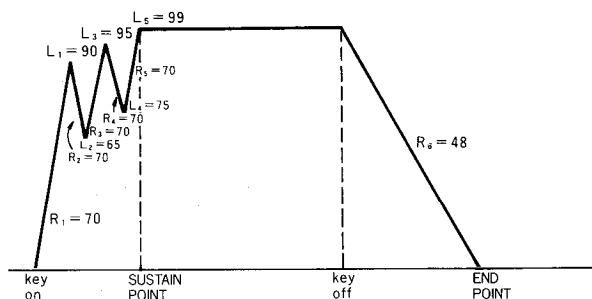

### (5) Effective ways of using the Detune Function

Select the Electric Piano sound and set the Detune parameters as follows.

+/-	Octave	Note	Fine	Effect
-	2	00	00	This produces a fatter sound.
-	1	00	00	This produces a fatter sound.
- ~ +	0	00	01 ~ 07	This setting can be used to achieve an ensemble effect. It is particularly effective in combination with the Line Select setting <b>[1]</b> + <b>[1]</b> .
+	1	00	00 ~ 07	Produces a fatter sound. This setting accentuates the harmonics one octave above the basic pitch.
+	1	07	00	This setting accentuates the third harmonics. It is well suited to brass and organ sounds.
+	2	00	00 ~ 07	This setting accentuates the harmonics two octaves above the basic pitch. Suited to electric piano sounds and electric organ sounds.
+	2	03	48	This setting accentuates the fifth harmonics. (The sound of hitting wood)
+	2	09	36	This setting accentuates the sixth harmonics.
+	3	00	00	This setting accentuates the seventh harmonics.
+	3	00	00	This setting accentuates the harmonics three octaves above the basic pitch.
+	3	02	00	This setting accentuates the ninth harmonics.
+	3	03	48	This setting accentuates the tenth harmonics.
+	3	05	30	This setting accentuates the eleventh harmonics.
+	3	07	00	This setting accentuates the twelfth harmonics. (The sound of hitting glass)
+	3	08	24	This setting accentuates the thirteenth harmonics.
+	3	09	36	This setting accentuates the fourteenth harmonics.
+	3	10	54	This setting accentuates the fifteenth harmonics. (Metallic sound)

**Note:** The values 36 and 48 for the FINE setting are to be considered as yardsticks that do not have to be adhered to precisely.

**Note:** Please consider the FINE settings as yardsticks. It is not necessary to set exactly the value listed in the table. Instead, any value close to the indicated one will suffice.

### • Ring Modulation

When Line Select is set to either  $\boxed{1} + \boxed{1}$  or  $\boxed{1} + \boxed{2}$ , the ring modulation effect can be used. To do so, press the RING MODULATION key. The sound of Line  $\boxed{1}$  will then be used to ring modulate Line  $\boxed{1}$  or Line  $\boxed{2}$  (which is achieved by multiplying their respective wave forms). The ring modulated sound will contain pitches that correspond neither to the pitch of Line  $\boxed{1}$  nor to the pitch of Line  $\boxed{1}$  or Line  $\boxed{2}$ , which is effective for metallic sounds such as bells.

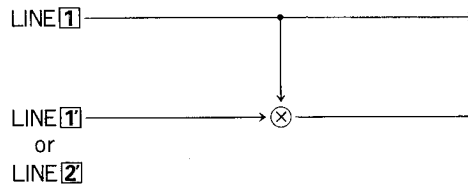

### • Noise Modulation

When Line Select is set to either  $\boxed{1} + \boxed{1}$  or  $\boxed{1} + \boxed{2}$ , the noise modulation effect can be used. To do so, press the NOISE MODULATION key. Line  $\boxed{1}$  or Line  $\boxed{2}$  will then be modulated by noise. This kind of modulation is effective for creating sound effects such as wind, waves, etc.

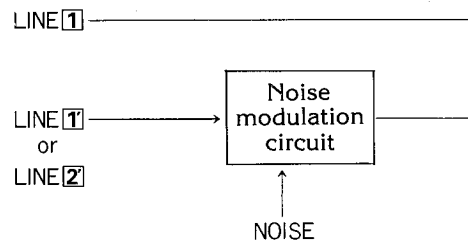

# *Appendix*

---

— The Essentials —

## “The Synthesizer Sound Seminar”

---

The synthesizer is an instrument which allows you to create your own sounds. Therefore, it is extremely important to know enough about the structure and of sounds. The following Appendix will give you all the essential information you need to use a synthesizer effectively.

# 1 What is Sound?

Every day, we hear a great variety of sounds. Speaking voices, the noise of car engines, the sound of doors opening and closing, of footsteps and of rain... and of music. In other words, we live our lives surrounded by sound. However, sound isn't something we can see with our eyes. So what is this thing called sound?

Many of you will remember that during physics lessons at school, you learned that "Sound is vibration". What does that mean? Taking the sound of a bell as an example, we will try to pursue the actual reality of sound as it is produced and as it is heard by our ears.

When kinetic (motional) energy is applied to a bell with a bell hammer as shown in figure 1, a "deformation" of the bell occurs, thus also causing energy to work which tries to restore the bell to its original state. A periodical repetition of deformation and restoration commences. This is called vibration.

This vibration causes pressure changes in the air, resulting in sections of the air which are denser and others which are rarefied occurring one after the other and expanding. These are called waves of condensation and rarefaction. The process is similar to the familiar one that occurs when circular surface waves are caused by a stone being thrown into water.

These waves of condensation and rarefaction are propagated into the human ear, where they cause the eardrum to vibrate. These vibrations are picked up by nerves so that we then hear them as "sound". If the vibrating body differs, so will the kind of vibrations meaning that we also hear a different kind of sound. Incidentally, outer space, where there is no air, is a world altogether without sound.

We hope that this explanation has clarified the meaning of sound as the vibrations of objects which are propagated through the air and picked up by the human ear to be heard as sound.

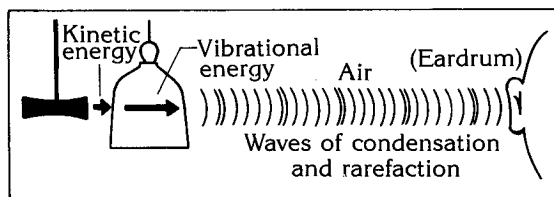

## Remember

Sound is vibration of the air.

# 2 What Are Wave Forms

## Seeing Sounds With Our Eyes

As explained before, sounds cannot be seen since they are vibrations of the air. However, you will often hear expressions such as "the wave form is different" or "this is almost a pure sine wave" concerning sounds. What is meant by "sound waves"?

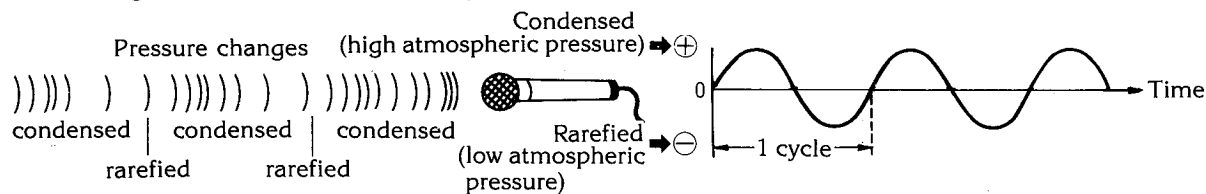

Let's consider the mechanism of a microphone which is used as a means for picking up sound. A microphone converts sound into electrical signals which can be then transmitted to an amplifier and speakers. As shown in the illustration, these electrical signals are simple conversions of the vibrations of the air, that is to say of the changes in atmospheric pressure, into electrical  $\oplus$  and  $\ominus$ . When these changes are presented in graphic form, they can be interpreted as "wave forms". An oscilloscope is a practical apparatus which also converts sounds into electrical signals and displays them as wave forms on a television screen. If we use this kind of a device, we can even see sounds with our own eyes.

What we see are "wave forms". These wave forms differ greatly according to the sound and have various characteristics. These points will be explained later on in the Appendix.

### Remember

If sounds are converted into electrical signals, they can be made visible as wave forms.

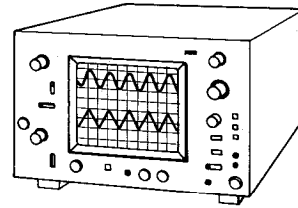

Oscilloscope

## What are the Three Basic Elements of Sound?

We now know that sound is vibration and that these can be seen by the eye as wave forms. But we have been talking about “sound” in general up to now without taking into consideration that there are high sounds and low sounds, loud sounds and quiet sounds, mellow sounds and sharp sounds ..... that is to say a great variety of sounds we perceive very differently. In general sounds can be classified according to “pitch”, “volume” and “tone quality”, which are called the “three basic elements of sound”. In other words, sounds are determined by these three basic elements.

### Remember

The “three basic elements of sound” are “pitch”, “volume” and “tone quality”.

We can now have a look at how these three basic elements are connected with the various wave forms.

## What is Pitch?

### — The “three basic elements of sound” ① —

When you hit the keys of a piano, you will notice that the sounds get higher the further a key is located on the right and lower the further a key is located on the left. This “altitude” of a sound, that is to say whether it is high or low, is called “pitch”.

When sounds with differing pitches are compared on an oscilloscope, you will notes that the number of waves per time unit differ. The higher a sound, the larger the number of waves, the lower a sound the smaller the number of waves.

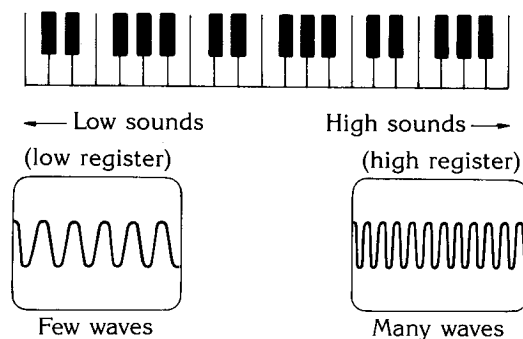

The number of waves is actually the number of the vibrations causing the sound. For example, if we are listening to a violin, it would be the number of vibrations of the strings within a certain period of time. The higher the sound the larger the number of vibrations per time unit, the lower the sound the smaller the number. The number of vibrations within the space of one second is generally called the frequency and expressed in units called Hz (Hertz). 100 Hz indicates that vibrations occur at the frequency of 100 times per second. The larger the number of Hertz, the higher the sound. Also note that doubling the frequency of a sound will raise it by one octave, so we can say that frequency and pitch are related logarithmically.

The range of frequencies that can be heard by the human ear depends on the individual but is generally considered to be in the approximate range of 20 Hz to 15,000 Hz.

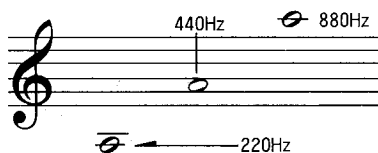

**Remember**

The pitch of a sound depends on the number of waves per time unit, in other words on the vibration frequency, and becomes higher the higher the frequency.

## What is Sound Volume?

### The “three basic elements of sound” ②

If you hit a piano key forcefully, the sound will be loud. If you hit it softly, the sound will be soft. When viewed on an oscilloscope, this change in sound volume can be seen as a difference in the height of the waves. The height of the waves is called their amplitude. The larger the amplitude the louder the sound.

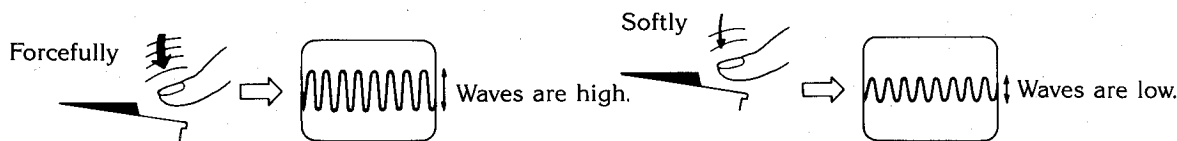

**NOTE**

The sound volume is determined by the amplitude (height of a wave) — the larger the amplitude the larger (louder) the volume.





# What is Tone Color

## The “three basic elements of sound” ③

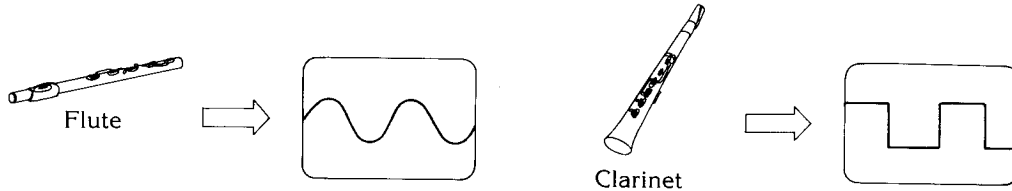
Even if you play a flute and a clarinet with the same pitch and about the same volume, you will not hear the same sound. That is because there is still one more distinguishing factor for sounds besides pitch and volume, namely “tone color”.



When you look at sounds with differing tone colors on the oscilloscope, you will notice that the wave forms themselves differ. It is this difference in wave form that is responsible for the difference in tone color. Generally speaking, rounded wave forms give softer tone colors, while “pointed” wave forms give hard, brilliant tone colors. Very basically, wave forms can be divided into the three types shown in the diagram on the right — sine waves, saw-tooth waves and square waves.

Wave form	Name	Tone color	Instrument it resembles
	Sine wave	Soft	Flute, whistle
	Saw-tooth wave	Bright	Violin, trumpet
	Square wave	Simple	Clarinet, oboe

The CZ-series offers you 8 basic wave forms. However, in order to understand the functioning of tone colorations as well as basic sound creation with the synthesizer, it is very important to first understand these three wave forms.

### Remember

The tone color depends on the form of the wave. There are three basic wave forms — sine wave, saw-tooth wave and square wave.

# 1 Basic Waves and Harmonics – Shaping the Tone Color

Now you would probably like to know how you can determine the shape of a wave (= tone color) in order to create the kind of sound you want. Well, please have a look at the diagram on the right first. It illustrates the process of combining two sine waves to form a saw-tooth wave. B is the basic sine wave while C has twice the frequency of B (it is thus one octave higher in pitch) and only half its amplitude (volume). When B and C are combined, the result is the wave form A. A is still not a perfect saw-tooth wave, but it will infinitely approach a perfect saw-tooth shape if sine waves with triple (3x), quadruple (4x), quintuple (5x) etc. frequencies are added. If, on the other hand, only sine waves with odd numbered frequency multiples are added, the basic sine wave will gradually approach a square wave.

In this manner, any wave form can be created by adding a number of sine waves to a basic sine wave. The waves such as C with frequencies that are integral multiples of the frequency of the basic wave (in our case B) are called harmonics. In other words, the wave form and thus the tone color are determined by the kind of harmonics added to the basic sine wave. Put differently, almost all the sounds with their different tone colors that reach our ears include a variety of different harmonics, and it is these harmonics which are responsible for the countless characteristic tone colors.

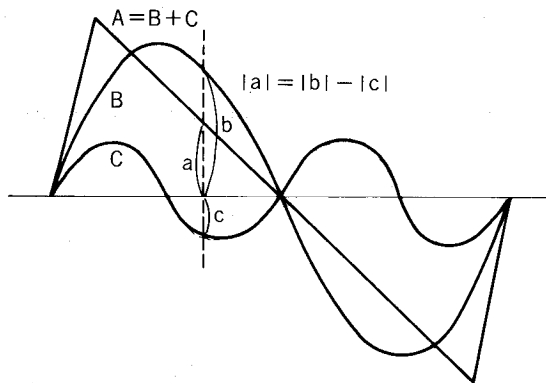

## ■ Saw-tooth wave



Harmonic components

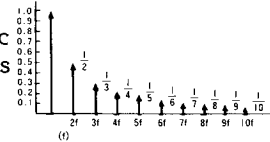

## ■ Square wave



Harmonic components

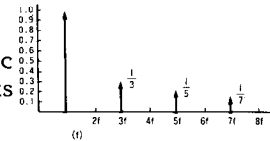

\* Graphs such as the ones above which show the harmonic components of a wave form are called "harmonic spectrums".

## NOTES

### • Musical sounds and non-musical sounds

Depending on its main kind of vibrations, sound is divided into "musical" and "non-musical" sounds. Sounds with regular vibrations (i.e. sounds where components other than harmonics are very few) are considered to be musical, while sounds caused by complicated irregular vibrations (i.e. sounds with many components that are not harmonics) whose pitch can therefore not be measured are called non-musical sounds.

Non-musical sounds also comprise unpleasant kinds of noise.

Most of the sounds used in music are of course musical sounds, but various kinds of noise such as that produced by percussion instruments are also used to heighten the musical effect.

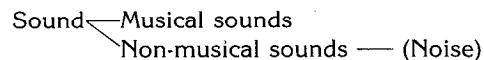

### • Pure Tones

Sounds which have no other components such as harmonics at all and consist of only one simple frequency are called pure tone. The wave form of a pure tone is always a perfect sine wave. The tone colors of a tuning fork or the telephone time tone are almost pure tones (perfect sine waves), but this kind of tone color does not exist in the natural world. Pure tones therefore can only be created artificially, e.g. electronically.

## Remember

- Frequencies which are integral multiples of a basic wave with a certain frequency are called harmonics.
- The tone color (wave form) is determined by the harmonic components.

# Envelopes

## — Other Factors Determining a Sound —

Besides the three basic elements of sound explained above, namely pitch, sound volume and tone color, there is another important factor which determines a sound. This is the variation of the sound over time. More precisely, it is the variation of each of the three elements over time from the beginning of the sound up to the point in time where it disappears completely. If a violin is played with a bow, for instance, the sound volume usually increases gradually and the tone color and pitch also change slightly. These changes over time are what determines the characteristic tone color of a violin. On the other hand, if the decaying sound of a piano were to be caused to continue without decaying, it would be very difficult to distinguish from the sound of a flute. These variations over time are called envelopes. Envelopes which have been expressed graphically such as those in the diagrams below are called envelope curves.

### Envelope Curves of Various Instruments (Sound Volume)

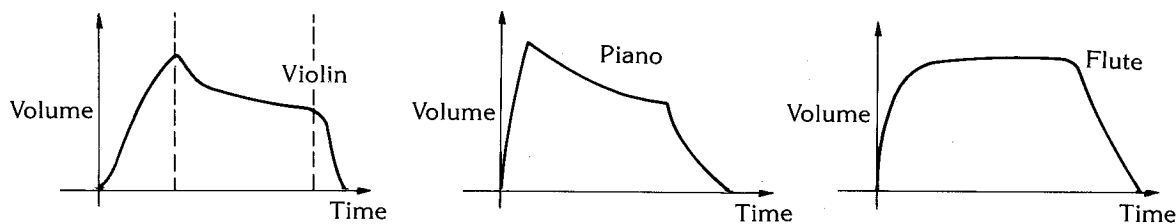

#### NOTE

Occasionally, the change of volume over time is also called an envelope.

#### Remember

The changes over time of pitch, volume and tone color are called envelopes. Envelopes are among the most important factors determining a sound.

# Basic Principles of Analog Synthesizer Structure

When people talk about synthesizers, you will often hear expressions such as VCO and VCF etc. Many of you who have heard such difficult words will therefore have found it difficult to approach synthesizers, believing they are too complicated. Actually, though, synthesizers are not that difficult to understand at all.

After all, analog synthesizers in general consist of various blocks which correspond to the three major elements of sound and the envelopes etc. explained above.

#### • VCO (Voltage Controlled Oscillator)

This circuit corresponds to the basic sound element "pitch" and determines the pitch of a sound by controlling voltage. This block is also used to create basic wave forms such as saw-tooth waves or square waves.

#### • VCF (Voltage Controlled Filter)

This circuit corresponds to the basic sound element "tone color" and alters the tone color by accentuating or filtering out certain harmonics of the wave forms created by the VCO. The VCF might be called the most important part of an analog synthesizer.

• **VCA (Voltage Controlled Amplifier)**

This circuit corresponds to the basic sound element “volume” and controls the volume of the sound created by the VCO and VCF.

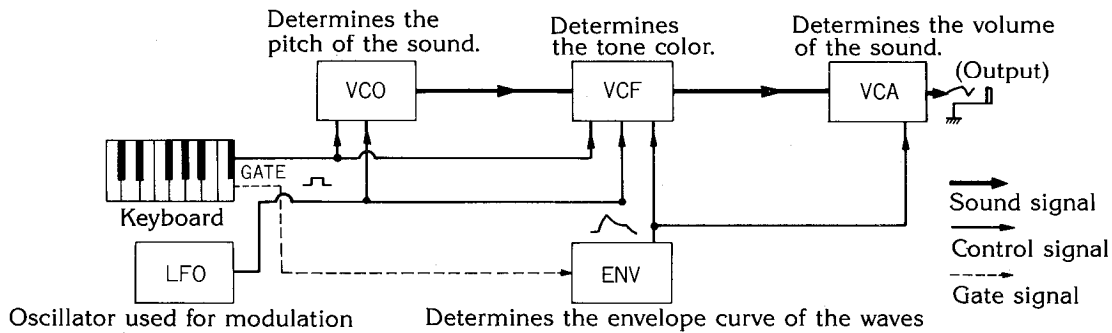

• **EG (Envelope Generator)**

Controls the change over time of volume, tone color etc., in other words the envelopes. The basic envelope curve consists of the four elements shown in the diagram on the right which can be controlled independently. The EG block is thus capable of creating a great variety of curves.

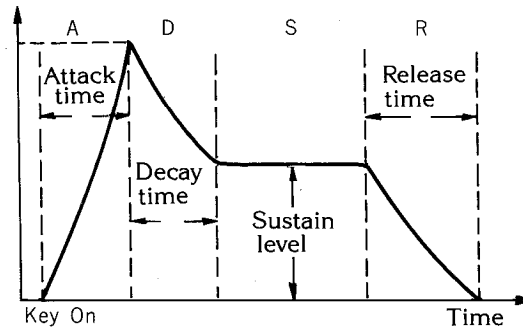

• **LFO (Low Frequency Oscillator)**

As this term indicates, the LFO is an oscillator operating at low frequencies. It can be used to control various other blocks to create effects such as vibrato.

**Remember**

The basic structure and functions of an analog synthesizer:

- **VCO:** Determines pitch (basic wave form)
- **VCF:** Creates the tone color
- **VCA:** Determines sound volume
- **EG:** Determines the envelope
- **LFO:** Used for various effects

**Note**

In the above, we have given you a general idea of how an analog synthesizer works. Of course, there are considerable differences according to the manufacturer and model.

# 10 Structure of the CZ-Series

We hope that the above has given you a good idea of how an analog synthesizer is structured and how this structure relates to the various aspects of sound. Finally, we would like to explain how the Casio CZ-series of digital synthesizers is designed.

While the CZ-series models are digital synthesizers, they are as easy to understand as any analog synthesizer since they consist of blocks that correspond closely to those making up an analog synthesizer, as shown in the diagram below. Anybody who knows the basics concerning analog synthesis will therefore find it very easy to create any sounds they want with the CZ-series. Even total beginners will be able to enjoy sound synthesis almost immediately by simply mastering the contents of this "Sound Synthesis Seminar".

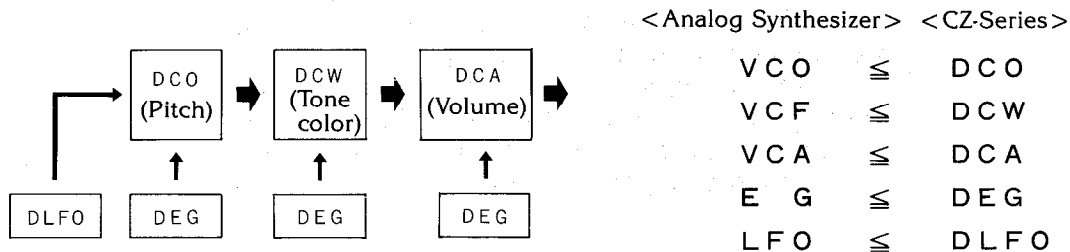

\* For more details on the structure of the CZ-series, see Part 2, "CZ-Series Sound Synthesis" (page 9).

**CASIO®**